

DUSTTRAK™
ENVIRONMENTAL
MONITOR
MODELS 8540, 8543
8540-M, 8542-M, 8543-M

OPERATION AND SERVICE MANUAL

P/N 6008408, REVISION M
SEPTEMBER 2021



深圳市展业达鸿科技有限公司
Shenzhen Things Test Technology CO.,LTD

Copyright ©

TSI Incorporated / 2015-2021 / All rights reserved.

Address

TSI Incorporated / 500 Cardigan Road / Shoreview, MN 55126 / USA

Fax No.

(651) 490-3824

Limitation of Warranty and Liability (effective February 2015)

(For country-specific terms and conditions outside of the USA, please visit www.tsi.com.)

Seller warrants the goods, excluding software sold hereunder, under normal use and service as described in the operator's manual, shall be free from defects in workmanship and material for twenty-four (24) months, or if less, the length of time specified in the operator's manual, from the date of shipment to the customer. This warranty period is inclusive of any statutory warranty. This limited warranty is subject to the following exclusions and exceptions:

- a. Hot-wire or hot-film sensors used with research anemometers, and certain other components when indicated in specifications, are warranted for 90 days from the date of shipment;
- b. DustTrak Environmental pump for Models 8540, 8543, 8540-M, 8542-M, and 8543-M is warranted for two (2) years or 8760 hours, whichever comes first.
- c. Parts repaired or replaced as a result of repair services are warranted to be free from defects in workmanship and material, under normal use, for 90 days from the date of shipment;
- d. Seller does not provide any warranty on finished goods manufactured by others or on any fuses, batteries or other consumable materials. Only the original manufacturer's warranty applies;
- e. This warranty does not cover calibration requirements, and seller warrants only that the instrument or product is properly calibrated at the time of its manufacture. Instruments returned for calibration are not covered by this warranty;
- f. This warranty is **VOID** if the instrument is opened by anyone other than a factory authorized service center with the one exception where requirements set forth in the manual allow an operator to replace consumables or perform recommended cleaning;
- g. This warranty is **VOID** if the product has been misused, neglected, subjected to accidental or intentional damage, or is not properly installed, maintained, or cleaned according to the requirements of the manual. Unless specifically authorized in a separate writing by Seller, Seller makes no warranty with respect to, and shall have no liability in connection with, goods which are incorporated into other products or equipment, or which are modified by any person other than Seller.

The foregoing is **IN LIEU OF** all other warranties and is subject to the **LIMITATIONS** stated herein. **NO OTHER EXPRESS OR IMPLIED WARRANTY OF FITNESS FOR PARTICULAR PURPOSE OR MERCHANTABILITY IS MADE. WITH RESPECT TO SELLER'S BREACH OF THE IMPLIED WARRANTY AGAINST INFRINGEMENT, SAID WARRANTY IS LIMITED TO CLAIMS OF DIRECT INFRINGEMENT AND EXCLUDES CLAIMS OF CONTRIBUTORY OR INDUCED INFRINGEMENTS. BUYER'S EXCLUSIVE REMEDY SHALL BE THE RETURN OF THE PURCHASE PRICE DISCOUNTED FOR REASONABLE WEAR AND TEAR OR AT SELLER'S OPTION REPLACEMENT OF THE GOODS WITH NON-INFRINGEMENTS.**

TO THE EXTENT PERMITTED BY LAW, THE EXCLUSIVE REMEDY OF THE USER OR BUYER, AND THE LIMIT OF SELLER'S LIABILITY FOR ANY AND ALL LOSSES, INJURIES, OR DAMAGES CONCERNING THE GOODS (INCLUDING CLAIMS BASED ON CONTRACT, NEGLIGENCE, TORT, STRICT LIABILITY OR OTHERWISE) SHALL BE THE RETURN OF GOODS TO SELLER AND THE REFUND OF THE PURCHASE PRICE, OR, AT THE OPTION OF SELLER, THE REPAIR OR REPLACEMENT OF THE

GOODS. IN THE CASE OF SOFTWARE, SELLER WILL REPAIR OR REPLACE DEFECTIVE SOFTWARE OR IF UNABLE TO DO SO, WILL REFUND THE PURCHASE PRICE OF THE SOFTWARE. IN NO EVENT SHALL SELLER BE LIABLE FOR LOST PROFITS, BUSINESS INTERRUPTION OR ANY SPECIAL, INDIRECT, CONSEQUENTIAL OR INCIDENTAL DAMAGES. SELLER SHALL NOT BE RESPONSIBLE FOR INSTALLATION, DISMANTLING OR REINSTALLATION COSTS OR CHARGES. No Action, regardless of form, may be brought against Seller more than 12 months after a cause of action has accrued. The goods returned under warranty to Seller's factory shall be at Buyer's risk of loss, and will be returned, if at all, at Seller's risk of loss.

Buyer and all users are deemed to have accepted this LIMITATION OF WARRANTY AND LIABILITY, which contains the complete and exclusive limited warranty of Seller. This LIMITATION OF WARRANTY AND LIABILITY may not be amended, modified or its terms waived, except by writing signed by an Officer of Seller.

Service Policy

Knowing that inoperative or defective instruments are as detrimental to TSI as they are to our customers, our service policy is designed to give prompt attention to any problems. If any malfunction is discovered, please contact your nearest sales office or representative, or call TSI's Customer Service department at (800) 680-1220 (USA) or (001 651) 490-2860 (International) or visit www.tsi.com.

CONTENTS

SAFETY INFORMATION	V
Laser Safety	v
Labels	vi
Description of Caution/Warning Symbols	vii
Caution	vii
Warning	vii
Caution and Warning Symbols	vii
Reusing and Recycling	viii
CHAPTER 1 PRODUCT OVERVIEW	1
DustTrak™ Environmental Monitors (Model 8540, 8540-M, and 8542-M).....	1
DustTrak™ DRX Environmental Monitors (Model 8543 and 8543-M).....	1
Models 8540-M, 8542-M, and 8543-M MCERTS Certified Monitors ..	2
854201-M1: MCERTS PM10 Indicative Certification	2
854001-M1: MCERTS PM2.5 Indicative Certification	2
854301-M1: MCERTS PM10 and PM2.5 Indicative Certification..	3
CHAPTER 2 UNPACKING AND PARTS IDENTIFICATION.....	5
Unpacking the DustTrak™ Monitor	5
User Replaceable Internal Parts	6
Optional Accessories	7
Parts Identification for the DustTrak™ Environmental Models 8540/8540-M/8542-M/8543/8543-M	8
CHAPTER 3 SETTING UP	11
Environmental Enclosure.....	11
Supplying Power to the DustTrak™ Environmental Monitor	12
Omni-directional Inlet Column	13
Optional accessory 854040.....	13
Zero Calibration of Instrument.....	13
Instrument Setup and Operation Options	14
DustTrak™ Checkout Application	15
DustTrak™ Checkout Application	16
CHAPTER 4 TRAKPRO™ SOFTWARE QUICK REFERENCE	21
Connecting to the Computer.....	21
Installing TrakPro™ Data Analysis Software	21
TrakPro™ Software Steps.....	22
Establishing Communications with the Instrument.....	22
Configuring the Logging Parameters.....	22
Setting User Calibration Factors	25
Starting a DustTrak™ Sample Run	30

Downloading Data	32
Viewing, Graphing and Exporting Data	32
Local Analog/Alarm Output	33
Wiring the Analog Output	33
Wiring the Alarm	34
Using TrakPro™ Software to Program the Analog Output.....	34
Using TrakPro™ Software to Program Alarm Setpoints	36
CHAPTER 5 MAINTENANCE	39
Maintenance Schedule.....	39
Cleaning the Inlet.....	40
Cleaning and Oiling Impactors.....	42
Replacing the Internal Sheath Air (HEPA) Filter	43
Replacing Pump	45
Replacing Internal 37-mm Sampling Cassette	48
Return Shipping to TSI® Incorporated.....	51
CHAPTER 6 TROUBLESHOOTING	53
APPENDIX A SPECIFICATIONS	55
APPENDIX B INSTRUMENT COMMAND SET	57
Connecting to the Instrument.....	57
NIDS Communication Method	57
APPENDIX C DRX ADVANCED CALIBRATION	59
Option 1: Serial Gravimetric Calibration	59
Step 1: PCF Calibration.....	59
Step 2: SCF Calibration.....	59
Option 2: Parallel Gravimetric Calibration	60

Application Notes can also be found on TSI® Incorporated's web site:
<https://www.tsi.com>

Safety Information

Laser Safety

- Models 8540/8543/8540-M/8542-M/8543-M DustTrak™ Environmental Monitors are Class I laser-based instruments.
- During normal operation, you **WILL NOT** be exposed to laser radiation.
- Precaution should be taken to avoid exposure to hazardous radiation in the form of intense, focused, visible light.
- Exposure to this light may cause blindness.

Take these precautions:

- **DO NOT** remove any parts from the DustTrak™ Environmental Monitor unless you are specifically told to do so in this manual.



WARNING

The use of controls, adjustments, or procedures other than those specified in this manual may result in exposure to hazardous optical radiation.











WARNING

If the DustTrak™ monitor is used in a manner not specified by the manufacturer, the protection provided by the equipment may be impaired.

When operated according to the manufacturer's instructions, this device is a Class I laser product as defined by U.S. Department of Health and Human Services standards under the Radiation Control for Health and Safety Act of 1968. A certification and identification label like the one shown below is affixed to each instrument.

Labels

Advisory labels and identification labels are attached to the instrument.

<p>1. Serial Number Label (back)</p>	<p>DUSTTRAK™ DRX — Model 8543 SN 8543151401 MFD APRIL 2015 CLASS I LASER PRODUCT COMPLIES WITH 21 CFR 1040.10 AND 1040.11 TSI Inc. 500 Cordigan Road Shoreview, MN 55128 U.S.A. www.tsi.com</p>    <p>12/24V – 50W Made in USA</p>	
<p>2. Laser Radiation Label (internal)</p>	<p>DANGER! VISIBLE LASER RADIATION WHEN OPEN. AVOID DIRECT EXPOSURE TO BEAM WARNING: NO USER SERVICEABLE PARTS INSIDE. REFER SERVICING TO QUALIFIED PERSONNEL</p>	
<p>3. Calibration Label (back)</p>	<p> Calibrated Customer Service 1-800-874-2811 Outside US 001-651-490-2811 www.tsi.com Date: January 2021</p>	
<p>4. IP Label (back)</p>	<p>USB IP Address: 199.254.130.225</p>	
<p>5. European symbol for non-disposable item. Item must be recycled.</p>		
<p>6. MCERTS Certification Label(s)</p>		
 <p>mcERTS THE ENVIRONMENT AGENCY'S MONITORING CERTIFICATION SCHEME Sira MC160316/XX</p>	 <p>mcERTS THE ENVIRONMENT AGENCY'S MONITORING CERTIFICATION SCHEME Sira MC160317/XX</p>	 <p>mcERTS THE ENVIRONMENT AGENCY'S MONITORING CERTIFICATION SCHEME Sira MC160318/XX</p>
<p>854201-M1</p>	<p>854001-M1</p>	<p>854301-M1</p>

Description of Caution/Warning Symbols

Appropriate caution/warning statements are used throughout the manual and on the instrument that require you to take cautionary measures when working with the instrument.

Caution



CAUTION

Failure to follow the procedures prescribed in this manual might result in irreparable equipment damage. Important information about the operation and maintenance of this instrument is included in this manual.

Warning






WARNING

Warning means that unsafe use of the instrument could result in serious injury to you or cause damage to the instrument. Follow the procedures prescribed.

Caution and Warning Symbols

The following symbols may accompany cautions and warnings to indicate the nature and consequences of hazards:

	Warns that the instrument contains a laser and that important information about its safe operation and maintenance is included in the manual.
	Warns that the instrument is susceptible to electrostatic discharge (ESD) and ESD protection should be followed to avoid damage.
	Indicates the connector is connected to earth ground and cabinet ground.

Reusing and Recycling



As part of TSI® Incorporated's effort to have a minimal negative impact on the communities in which its products are manufactured and used:

- ❌ **DO NOT** dispose of used batteries in the trash. Follow local environmental requirements for battery recycling.
- ♻️ If instrument becomes obsolete, return to TSI® for disassembly and recycling.

Chapter 1

Product Overview

DustTrak™ Environmental Models 8540, 8540-M, and 8542-M and DustTrak™ DRX Environmental Models 8543 and 8543-M Monitors are data-logging, light-scattering laser photometers that provide real-time mass concentration readings for aerosol contaminants such as dust, smoke, fumes and mist. These instruments use a sheath air system that isolates the aerosol in the optics chamber to keep the optics clean for improved reliability and low maintenance. These monitors offer a suitable solution for long-term outdoor monitoring, construction and environmental clean-up sites.

DustTrak™ Environmental Monitors (Model 8540, 8540-M, and 8542-M)

The DustTrak™ Environmental Monitors are continuous, real-time, single-channel, 90° light-scattering laser photometers that are used to determine the mass concentration of aerosols. A robust, long-life pump allows for the use of a variety of size-selective inlet conditioners to measure aerosol concentrations corresponding to PM₁₀, or PM_{2.5}.

DustTrak™ DRX Environmental Monitors (Model 8543 and 8543-M)

The DustTrak™ DRX Environmental Monitors are continuous, real-time light-scattering laser photometers that simultaneously measure size-segregated mass fraction concentrations corresponding to PM₁, PM_{2.5}, and PM₁₀—something no other monitor can do. The instrument combines both particle cloud (total area of scattered light) and single particle detection to achieve mass fraction measurements. This size-segregated mass fraction measurement technique is superior to either a basic photometer or optical particle counter (OPC). It delivers the mass concentration of a photometer and the size resolution of an OPC.

The DustTrak™ Environmental Monitors are designed to operate inside the TSI® Environmental Enclosure (Model 854038) which has an International Protection Marking of IP44. The DustTrak™ Environmental Monitor should not be used outdoors without an appropriate weather-proof enclosure.

Models 8540-M, 8542-M, and 8543-M MCERTS Certified Monitors

DustTrak™ Environmental Monitor Models 854201-M1, 854001-M1 or 854301-M1, have been designed to meet the UK's MCERTS (Monitoring Certification Scheme) for indicative instruments. **The following must be installed for these models to meet the MCERTS Indicative Certification:**

854201-M1: MCERTS PM10 Indicative Certification

- 8542-M Photometer
- 854038 Environmental Enclosure
- 854020 PM10 Impactor
- 854041 Heated Inlet
- PCF set at 0.53 (preset at the factory). It is recommended that the instrument is run with a Photometric Correction Factor (PCF) of 0.53. However, the application of a site specific correction factor may be used if a significant decrease in the expanded uncertainty can be demonstrated.



854001-M1: MCERTS PM2.5 Indicative Certification

- 8540-M Photometer
- 854038 Environmental Enclosure
- 854021 PM2.5 Impactor
- 854041 Heated Inlet
- PCF set at 0.33 (preset at the factory). It is recommended that the instrument is run with a Photometric Correction Factor (PCF) of 0.33. However, the application of a site specific correction factor may be used if a significant decrease in the expanded uncertainty can be demonstrated.



854301-M1: MCERTS PM10 and PM2.5 Indicative Certification

- 8543-M Photometer
- 854038 Environmental Enclosure
- 854041 Heated Inlet
- PCF PM2.5 set at 0.47, PM10 set at 0.53 (preset at the factory). It is recommended that the instrument is run with a Photometric Correction Factor (PCF) of 0.53. However, the application of a site specific correction factor may be used if a significant decrease in the expanded uncertainty can be demonstrated.







Chapter 2



Unpacking and Parts Identification

Carefully unpack the Model 8540/8540-M/8542-M/8543/8543-M DustTrak™ Environmental Monitor from the shipping container. Use the tables and illustrations below to make certain that there are no missing components. Contact TSI® immediately if anything is missing or damaged.



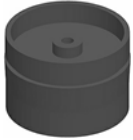
Unpacking the DustTrak™ Monitor

Compare all the components you received with those listed in the table below. If any parts are missing, contact TSI®.





Item	Qty	Part Number	Description
	1	8540 8540-M 8542-M 8543 8543-M	DustTrak™ Environmental Monitor DustTrak™ DRX Environmental Monitor
	1	1090014	Data Analysis Software CD-ROM
	1	1303740	USB cable
	1	854052	12 VDC power supply




Item	Qty	Part Number	Description
	1	6008408	Operation and Service Manual
	1	N/A	Calibration Certificate

User Replaceable Internal Parts

Item	Part Number	Description
	854044	Sheath Air Filter
	854043	Pump
	NA	37-mm, 2-piece, static conductive cassette
<p>Blank replacement cassettes or media can be ordered from www.zefon.com. 37-mm 2-piece blank cassette product # 37MMH-2-CF Zefon can also supply pre-weighed filter media for gravimetric sampling.</p>		

Optional Accessories

Item	Part Number	Description
	854038	Environmental Enclosure
	801905	Netronix™ Thiamis™ 1000 Communication Node
	854040	Omni-directional Inlet w/Water Trap Bottle
	854041	Heated Inlet Sample Conditioner

Item	Part Number	Description
	854039	Enclosure Power Supply
	854042	Water Trap Bottle
	854020	PM ₁₀ Impactor
	854021	PM _{2.5} Impactor
	854022	PM _{1.0} Impactor

Parts Identification for the DustTrak™ Environmental Models 8540/8540-M/8542-M/8543/8543-M

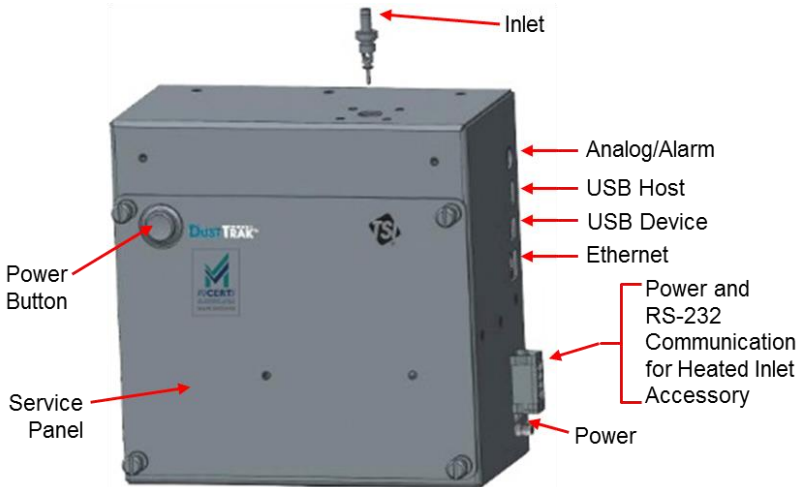


Figure 1: Features on Models 8540/8540-M/8542-M/8543/8543-M

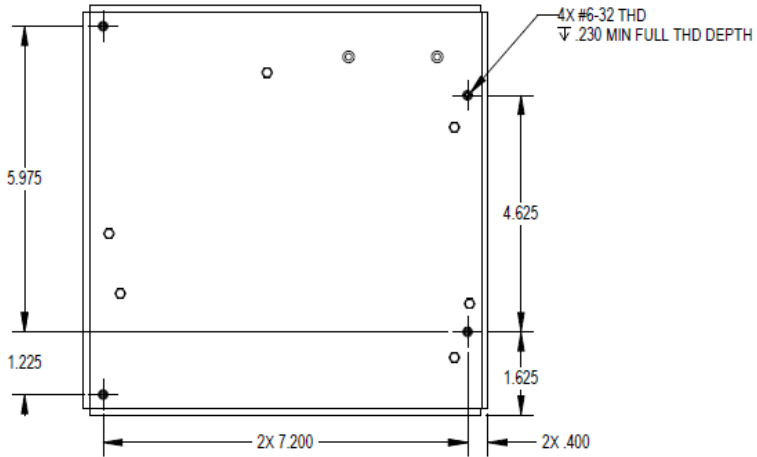


Figure 2: Back panel interface control dimensions

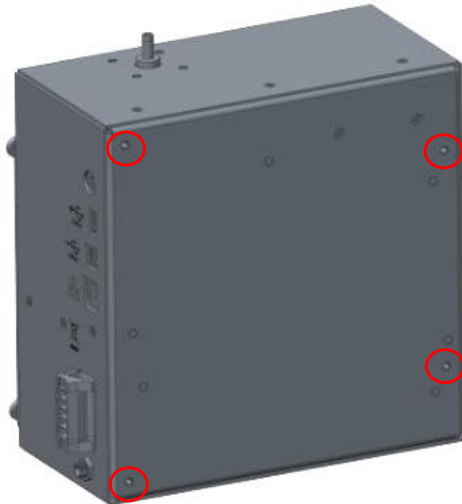


Figure 3: View of back panel with mounting holes shown

Holes are pre-drilled in the back of the photometer to enable users to develop their own mounting bracket for attaching the photometer into an alternate enclosure.

Mounting the photometer using these holes will need quantity four (4) #6-32 screws that penetrate no deeper than 0.230" into the back panel of the photometer.

Chapter 3

Setting Up

Environmental Enclosure

The DustTrak™ Environmental Monitor is designed to be mounted inside in the environmental enclosure. TSI® part number 854038 Environmental Enclosure has been designed specifically to protect the DustTrak™ Environmental Monitor and its accessories. See *Environmental Enclosure Model 854038 Operation and Maintenance Manual* (P/N 6012377) for more details and installation instructions.



Figure 4: Environmental Enclosure
(as shown with optional accessories
Omni-directional inlet and solar shield)

Supplying Power to the DustTrak™ Environmental Monitor

One method for supplying power to the instrument is to use the 12V power supply (TSI® P/N 854052). Fasten the barrel connector to the instrument as shown in Figure 5. This power supply comes with a region-specific power cord and is mainly used to power the instrument when it is not mounted inside of the enclosure and communication is required for diagnostics and programming.



Figure 5: Instrument power connection

If the instrument is installed into the 854038 Environmental Enclosure, power options include AC Power Supply (854039), AC power supply included with enclosure heater (854054), Rechargeable Battery Power System (854036), and Solar Power System (854060).

Omni-directional Inlet Column

Optional accessory 854040

See the Quick Start Guide installing impactors PM₁₀ (854020), PM_{2.5} (854021), PM₁ (854022) onto the omni-directional inlet for details.



Figure 6: Inlet, water trap and base with connection rings

Zero Calibration of Instrument

The DustTrak™ Environmental Monitor has the ability to automatically “Zero” the instrument readings at programmed intervals. “Zeroing” the instrument resets the photo detector, to a signal that represents no particles flowing through the optics. Over time, photometric light-scattering instrument readings can drift due to changes in temperature and aerosol build up in the optics. Programming regular “Zero” events corrects the photometric signal to account for these changes.

The DustTrak™ Environmental Monitor automatically performs a zero calibration when the instrument begins any programmed run and the auto zero function has been enabled. Use the instructions detailed in [Chapter 4](#) for enabling auto zero and configuring the automatic interval using the TrakPro™ software.

Instrument Setup and Operation Options



Figure 7: Setting up instrument and operating options

Press the power button to turn on instrument. The button will turn blue, indicating the instrument has power and is turned on.

To turn instrument off, hold the power button for 10 seconds and then release. The blue indicator light in the power button will turn off, indicating the instrument has shut down.

Use the DustTrak™ Checkout Software or Netronix™ Environet (both explained below) to read the instrument status, program instrument, and activate instrument programmed runs.

The DustTrak™ instrument can be setup and controlled using one of three options:


- Use TrakPro™ Data Analysis Software to configure instrument, run instrument and download data. Quick start information for using TrakPro™ software is shown in the section below.
- Use a Netronix™ Thiamis™ Communication Node and web-based application Environet to setup and control the DustTrak™ monitor remotely. See Netronix™ quick start guides for Netronix™ [installation](#) and [set-up](#).
- Use the DustTrak™ monitor's command set to develop a custom program for setting up and controlling the DustTrak™ monitor. See the command set information in [Appendix B](#).

DustTrak™ Checkout Application

- DustTrak™ Checkout Application enables a “virtual screen” for the DustTrak™ monitor. Instrument data, flow calibration, zero calibration, instrument diagnostics, etc., can be viewed or performed through the use of the checkout software.
- This software can be used as part of your field installation process to ensure the instrument is functioning properly, when Netronix™ is not being used or a web accessed device is not immediately available during field installation.

Open DustTrak™ Checkout executable file and follow the steps to run the installation wizard.

NOTES	
<ul style="list-style-type: none">• The DustTrak™ Checkout Application can also be downloaded from the TSI® website. Visit http://www.tsi.com/Software-Firmware/ and click on the Software and Firmware Wizard link. Follow the on-screen instructions to download the software.• Your computer must have the current version of TrakPro™ software to access the proper drivers to communicate with this Checkout Application.	

Name	Date modified	Type	Size
 EnvDTCheckoutInstall.exe	2/11/2015 12:41 PM	Application	4,038 KB

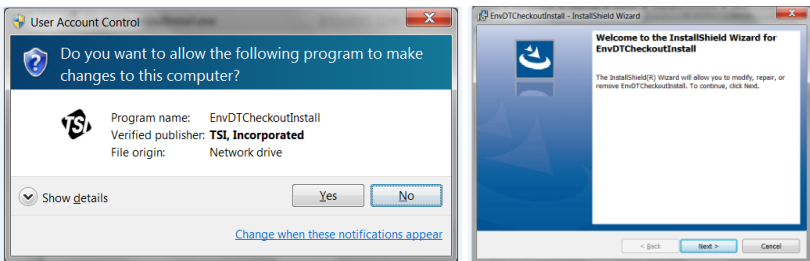


Figure 8: Checkout Application – Setup screen

DustTrak™ Checkout Application

After installing the application, plug the provided USB cable into the “USB B” port on the instrument and plug the other end into your computer. Power on the instrument and click the **Connect** button. The USB IP address and instrument information will appear when connected.

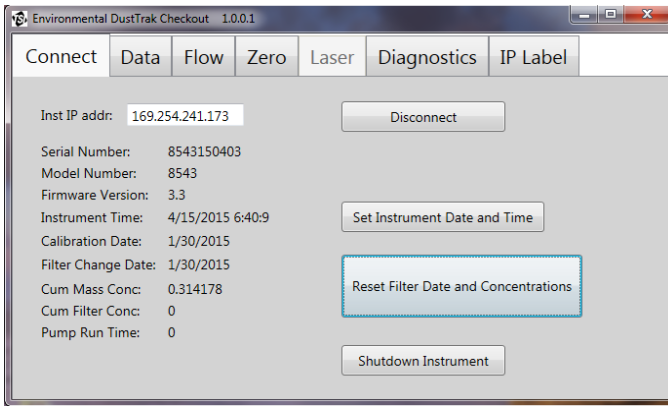


Figure 9: Checkout Application – Connect tab

Click the **Data** tab to access the current instrument readings.

Clicking the green arrow will start the instrument pump to begin sampling in Survey Mode. No data will be logged onto the instruments memory while running in Survey Mode.

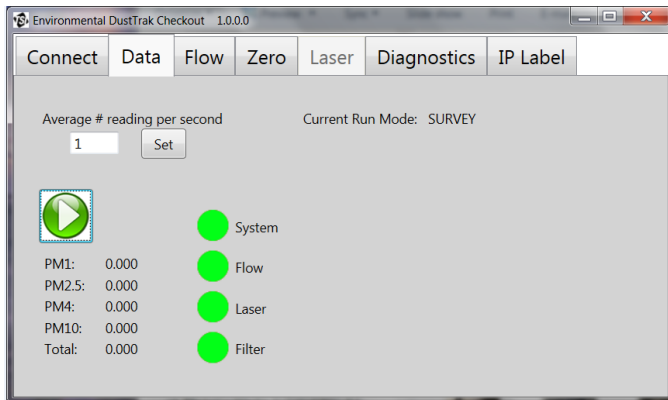


Figure 10: Checkout Application – Data tab

Click on the **Flow** tab to adjust the pump flow rate.

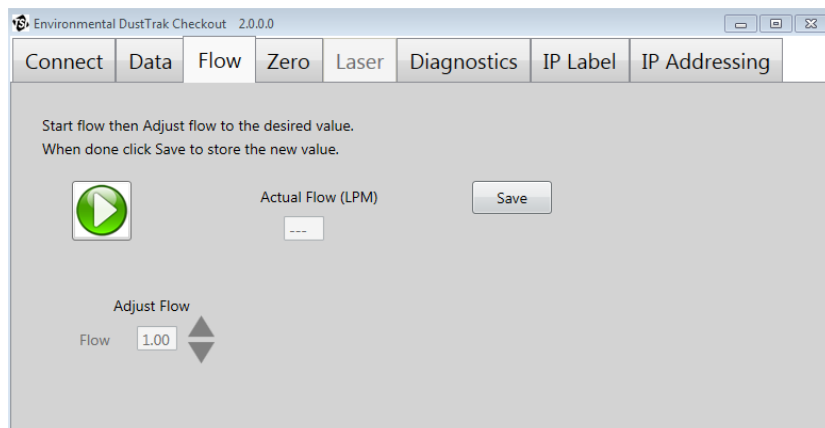


Figure 11: Checkout Application – Flow tab

Click the green arrow to start the pump, allowing for a change to the flow setpoint. The flow setpoint is factory set to 3 L/min total flow. 2 L/min of the total flow is measured aerosol flow. 1 L/min of total flow is split off, filtered, and used for sheath flow. There is an internal ΔP flow meter in the DustTrak™ instrument that controls flow rate to $\pm 5\%$ of the factory setpoint. TSI® recommends checking the flows with an external flow reference meter, especially when collecting data.

1. Attach a flow calibrator (reference flow meter) to inlet port. You may use a bubble buret, mass flow meter, dry piston or rotameter as flow measurement devices.
2. Click on the up or down arrows to achieve desired flow on the reference flow meter. Each click of the up or down arrow will change the flow about 1%. Allow time between button presses to let pump change to the new flow rate.
3. Click **Save** once the desired flow rate is achieved. Select **Undo** to return to the factory setpoint.

NOTE – Models 8540, 8540-M, 8542-M

The flow rate can be adjusted from approximately 1.5 to 4.0 L/min. If needed, this feature can be used to adjust the flow rate to a value other than the factory setpoint, allowing for the use with 3rd party size selective inlets (cyclones or impactors) that may require a different flow rate.

NOTE – Models 8543, 8543-M

The flow rate can be adjusted from approximately 1.5 to 4.0 L/min. This feature allows you to re-adjust the flow rate, if needed, to 3.0 L/min. The flow rate for the DRX models should remain fixed at 3.0 L/min. No size-selective inlets or cyclones should be installed on the inlet of the instrument during its normal operation.

Click on the **Zero** tab to manually perform a zero calibration for the instrument. Click **Start Zero** to start the zeroing process.

The “Last Zero” and “New Zero” values do not represent particle count or aerosol mass. These values are associated with the signal received by the photometric sensor when no particles are passing through the optics.

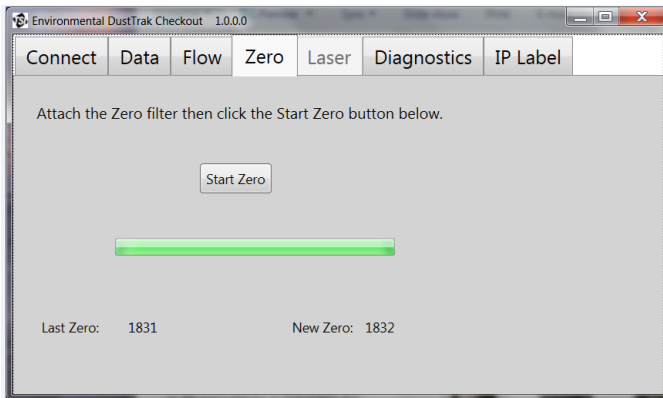


Figure 12: Checkout Application – Zero tab

The **Laser** tab is only accessible in password-protected “Engineering Mode.” Changes made to the Laser setting will directly affect the calibration, the instrument response, and is available only to TSI® technicians.

The **Diagnostics** tab opens a command window that can be used to send instructions to the instrument. Click **Send** or press the **Enter** key to send the command to the instrument. See the Communication Settings in [Appendix B](#).

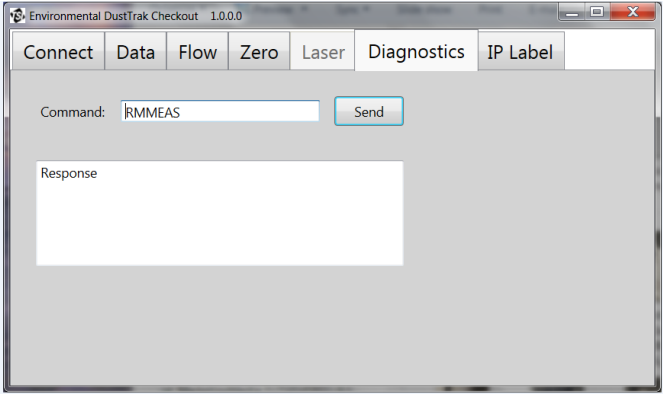


Figure 13: Checkout Application – Diagnostics tab

The **IP Label** tab opens a printer connection box and displays the instrument IP address.

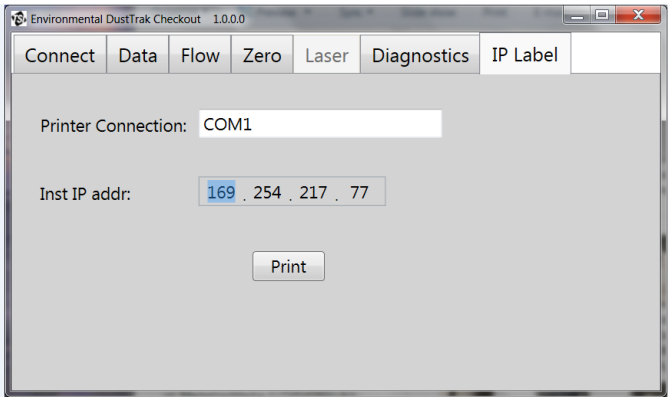


Figure 14: Checkout Application – IP Label tab

The **IP Addressing** tab can be used to change the settings for the instruments Ethernet IP address. After making changes, click **Save** for the settings to take effect.

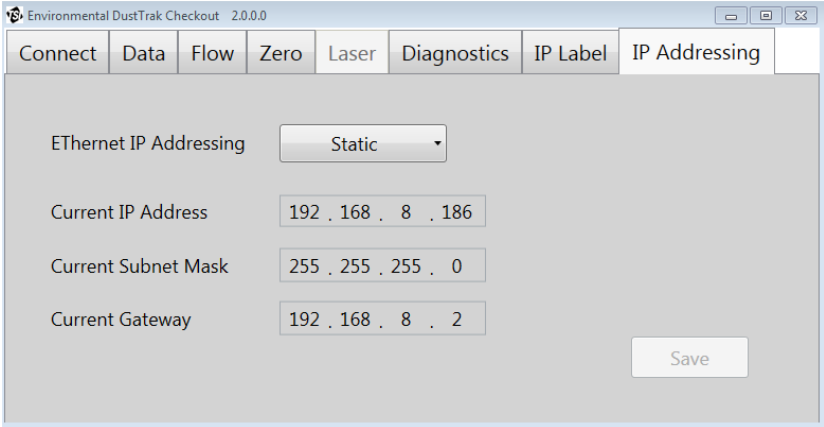


Figure 15: Checkout Application – IP Addressing

Chapter 4

TrakPro™ Software Quick Reference

Connecting to the Computer

The TrakPro™ software can be used to preprogram the instrument, download data, view and create raw data and statistical reports, create graphs, and combine graphs with data from other TSI® instruments that use TrakPro™ software. Connect the USB host port of a Microsoft® Windows®-based computer to the USB device port on the side of the DustTrak™ monitor.

Installing TrakPro™ Data Analysis Software

The following sections describe how to install the software and set up the computer.

NOTE

To use TrakPro™ software with the DustTrak™ Monitor, the PC must be running Microsoft® Windows® and the computer must have an available Universal Serial Bus (USB) port.

1. Insert the TrakPro™ Data Analysis Software CD into the CD-ROM drive. The install screen starts automatically.

NOTE

If the software does not start automatically after a few minutes, manually run the program listed on the label of the CD using the **Run** command on the Windows® Start Menu.

2. Follow the directions to install TrakPro™ software.

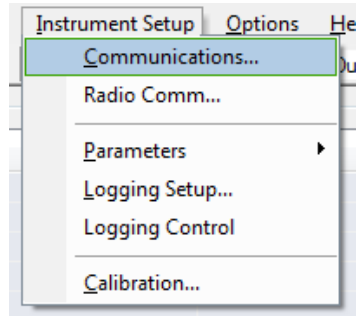
TrakPro™ software contains a comprehensive installation guide. TSI® recommends printing out this guide prior to starting the TrakPro™ software installation on your computer, so it may be consulted during the installation. The TrakPro™ software manual is located in the “Help” file in TrakPro™ software. There is no separately printed TrakPro™ Data Analysis software manual.

®Microsoft and Windows are registered trademarks of Microsoft Corporation.

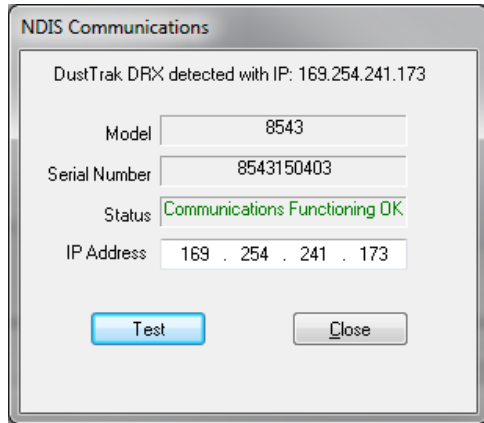
TrakPro™ Software Steps

Establishing Communications with the Instrument

Open up TrakPro™ software and select **Instrument Setup -> Communications**.

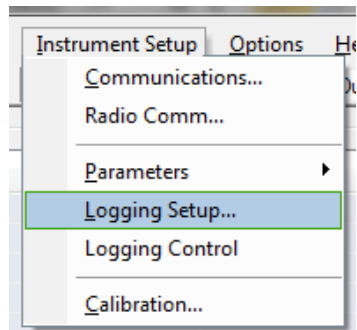


The software will automatically find the instrument, as shown in the dialog.



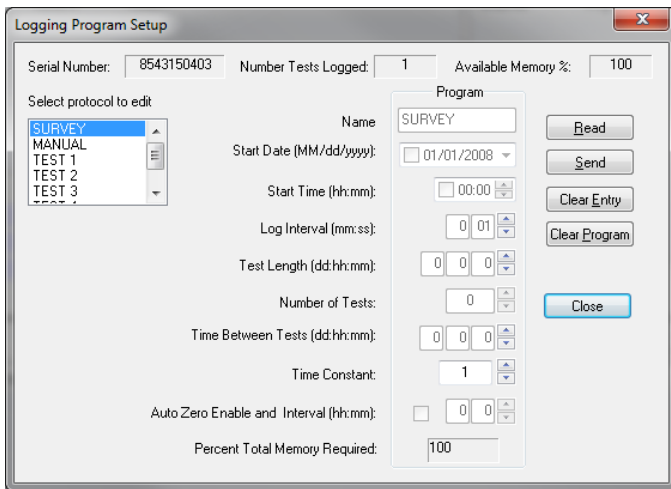
Configuring the Logging Parameters

Select **Instrument Setup -> Logging Setup**.

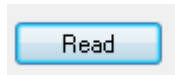


This will open a dialog allowing for the configuration of the different instrument run modes. The sampling mode options include Survey mode, Manual Mode and Program Logs 1-5.

Survey	Survey Mode runs a real time, continuous active sample, but does not log data.
Manual	Manual Log sets the instrument to log data for a specified run time.
Log Modes	Log Mode starts and stops the instrument at specified times, run for a specified test length, and perform multiple tests of the same length with a specified time period between tests.



Press the **Read** button to get the current log modes from the instrument.



Update the log modes to meet logging requirements. Details on log modes are in table below.

Survey Mode Options	
Time Constant	Time Constant can be set from 1 to 60 seconds.
Auto Start on Power Up	When set to "Yes", unit will start a measurement upon being powered on, if the unit was set to "Survey" when it was turned off. When set to "No", the unit will be in idle when it is powered on.

Manual Mode Options	
Log Interval	The log interval can be set from 1 second to 60 minutes. It is the amount of time between logged data points.
Test Length	Test length can be set from 1 minute to the limit of the data storage.
Time Constant	Not used for the 8540/8540-M/8542-M/8543/8543-M models.

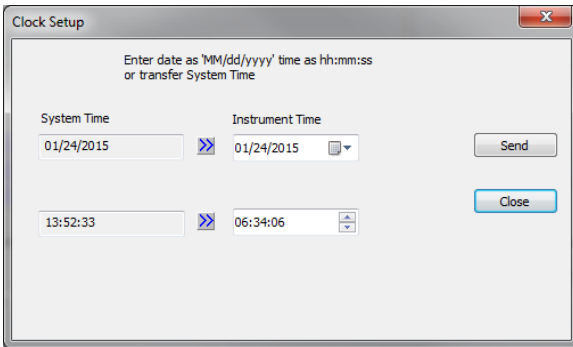
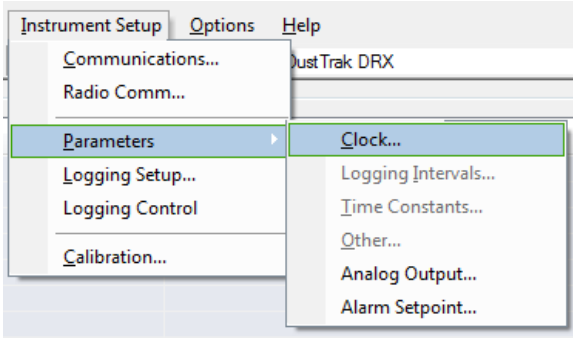
Program Log Options	
Log Name	Enter descriptive name for the log mode.
Start Date	Select the date and the test will start. Select the check box to use Start Date, option to use programmed start date, or bypass programmed start date.
Start Time	Select the time the test will start. Select the check box to use Start Time, option to use programmed start time or bypass programmed start time.
Log Interval	The log interval can be set from 1 second to 60 minutes. It is the amount of time between logged data points.
Test Length	From 1 minute to the limit of the data storage.
Number of Tests	1 to 999.
Time between Tests	1 minute to 30 days.
Time Constant	Not used for the 8540/8540-M/8542-M/8543/8543-M models.
Auto Zero Interval	Interval between re-zeroing the instrument using the built in autozero functionality. Use the check box to enable use of autozeroings.

Once the log modes have been updated, press the **Send** button to send the new log modes to the instrument.



If using a programmed start time and start date, update the instrument date and time to ensure the logging starts as planned.

Select **Instrument Setup -> Parameters -> Clock** to set the time.



Setting User Calibration Factors

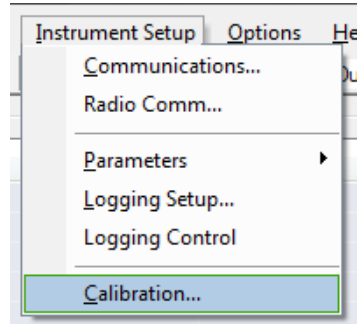
In most cases, a user calibration factor of 1 for photometric and size cal (DRX only) will be sufficient. Use the following instructions to change the instruments User Cal, if an improved calibration factor is required.

Set User Calibration Factor allows you to store and use 10 different calibration factors. In addition, there are preprogrammed factory defaults, one is the “Ambient Cal” and the other is the “Factory Cal” (8540-M, 8542-M and 8543-M also have an MCERTS cal). The “Ambient Cal” is appropriate for outdoor ambient dust or fugitive dust monitoring. The “Factory Cal” is the calibration to ISO 12103-1, A1 Arizona test dust for which a calibration certificate is provided with the instrument. The “Factory Cal” is appropriate for most workplace aerosol monitoring. Factory Cal can be set by simply setting both the

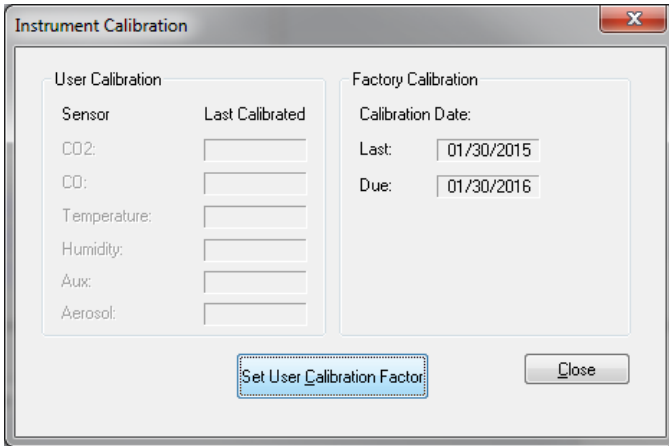
size correction factor (DRX model only) and the photometric calibration factor to 1.

Use the following steps to get to the user cal functionality:

Select **Instrument Setup -> Calibration**.

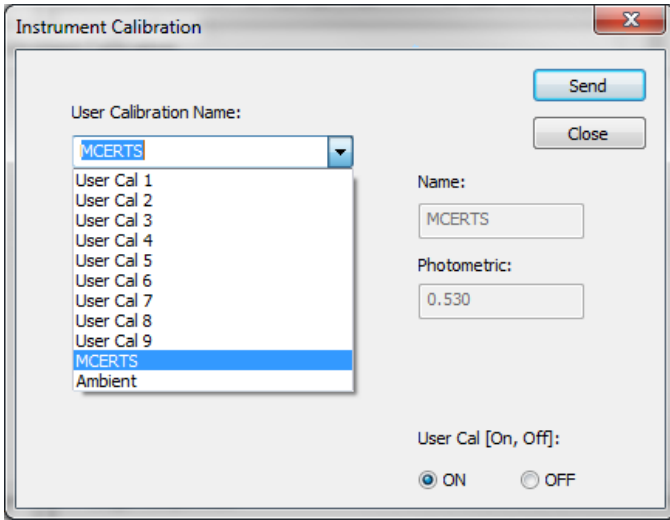


Click the **Set User Calibration Factor** button to access the instrument calibration settings.



In this dialog, you can select the factory ambient cal or customizable user cals 1 through 10, (1 through 9 for MCERTS models 8540-M,

8542-M and 8543-M). User Cals 1 through 10 can be used to set custom user calibration factors.



Four variables can be set for each user calibration.

Name	User can input a custom description for the custom User Calibration.
Photometric Calibration Factor	Changes the factory calibration of particle signal, based on Arizona Road Dust, to actual aerosol being measured.
Size Calibration Factor	Changes the factory calibration of the particle distribution, based on Arizona Road Dust, to actual aerosol being measured. This is for the DRX only. A setting of 1 works for most situations.
User Cal [on,off]	Selecting On will activate current user calibration and deactivate the previously selected user calibration.

Determining a new Photometric Calibration Factor

In most situations, the DustTrak™ monitor with its built-in data logging capability can provide very good information on how the concentration of an aerosol changes for different processes over time. Factory calibration to the respirable fraction of standard ISO 12103-1, A1 test dust is fairly representative of a wide variety of workplace aerosols. Because optical mass measurements are dependent upon particle size and material properties, there may be times in which a custom calibration would improve your accuracy for a specific aerosol.

Determining an aerosol-specific photometric calibration requires that you determine a true mass concentration (e.g., gravimetric analysis) for the aerosol you want to measure. The true mass concentration is used to calculate the custom calibration factor for that aerosol. Once you have a custom calibration factor, you can reuse it each time you make measurements in the same aerosol environment.

Determining the Calibration Factor for a Specific Aerosol

The DustTrak™ monitor is factory calibrated to the respirable fraction of standard ISO 12103-1, A1 test dust. The DustTrak™ monitor can be easily calibrated to any arbitrary aerosol by adjusting the custom calibration factor. The DustTrak™ monitor's custom calibration factor is assigned the value of 1.00 for the factory calibration to standard ISO test dust. This procedure describes how to determine the calibration factor for a specific aerosol. Using the value of 1.00 will always revert back to the factory calibration.

To determine a new calibration factor you need some way of accurately measuring the concentration of aerosol, hereafter referred to as the reference instrument. A gravimetric analysis is often the best choice, though it is limited to nonvolatile aerosols.

To make an accurate calibration you must simultaneously measure the aerosol concentration with the DustTrak™ monitor and your reference instrument.

1. Zero the DustTrak™ monitor.
2. Put the instrument in Manual Log (Manual Logging is reviewed later in this section).
3. Set the logging interval. One minute (i.e., "01:00") is often a good choice.

4. Co-locate the DustTrak™ monitor and the reference sampler together so that they are measuring from the same area.
5. Start sampling aerosol with both instruments at the same time.

NOTE

Greater accuracy will be obtained with longer samples. The time you permit for sampling often depends on the reference instrument and characteristics of the measured aerosol. It may take some time to collect sufficient aerosol onto a filter cassette for accurate gravimetric analysis. Refer to instructions of your reference instrument for sampling times.

6. Stop sampling with both instruments at the same time.
7. Record the DustTrak™ monitor average concentration by viewing the sample average by downloading the saved data to TrakPro™ software.
8. Determine the mass concentration in mg/m³ from your reference instrument. For gravimetric sampling this means weighing the gravimetric sample.

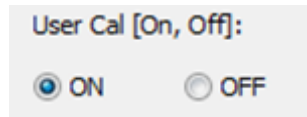
NOTES

- If you installed a gravimetric filter into the DustTrak™ monitor and are; therefore, using the DustTrak™ monitor to obtain a gravimetric sample, the flow rate used to compute the concentration should be 2 L/min, not 3 L/min since only 2 L/min of aerosol flow reaches the filter.
- To ensure proper fit into the DustTrak™ gravimetric holder, TSI® recommends using conductive, polypropylene, 2-piece 37-mm cassette housings.

9. Compute the new calibration constant, NewCal, using the following formula:

$$\text{NewCal} = \left(\frac{\text{Reference Concentration}}{\text{DustTrak Concentration}} \right) \cdot \text{CurrentCal}$$

10. Enter the new value into one of the custom user cals and turn that cal “on” using the radio button.

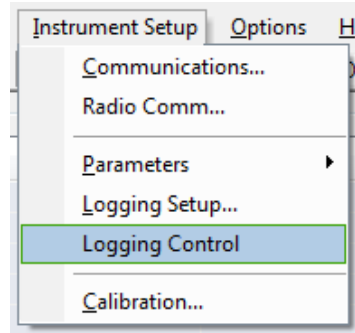


Starting a DustTrak™ Sample Run

Once a log mode is set and a calibration mode selected, the DustTrak™ monitor can be started using TrakPro™ software. To start a sample, perform the following steps.

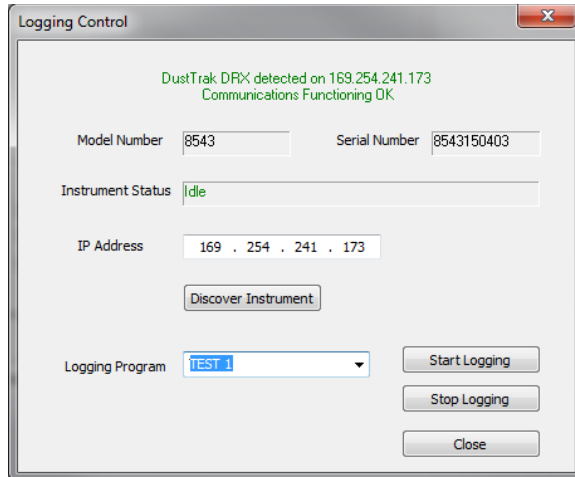
First select Logging Control

Select **Instrument Setup** -> **Logging Control**.

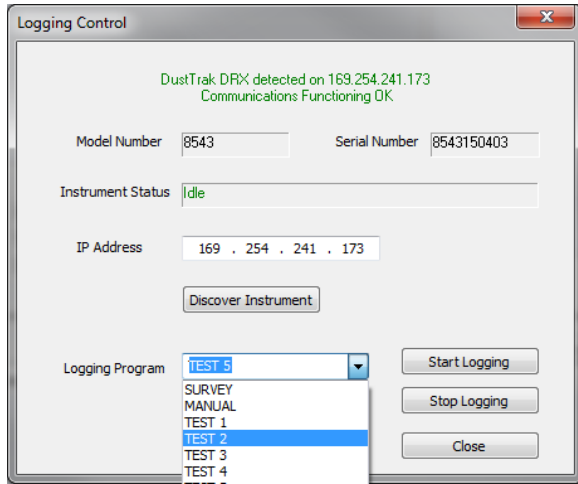


Next, establish communication with the instrument

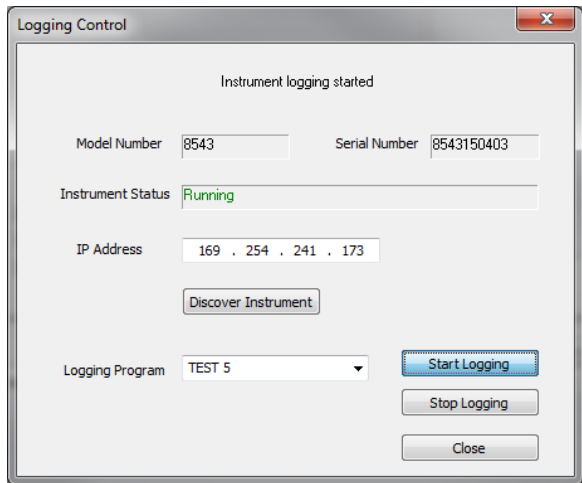
Press the **Discover Instrument** button.



Select your desired log mode from the Logging Program drop-down menu.



Press **Start Logging** to begin the logging.



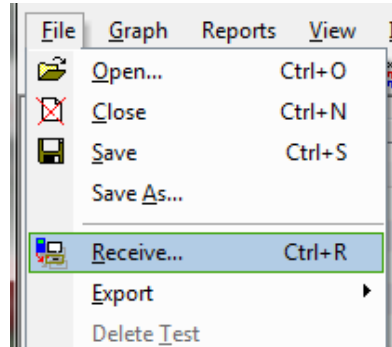
NOTE

If a start date and start time is selected, the instrument will not immediately start with the logging and will remain in idle unit the targeted date and time.

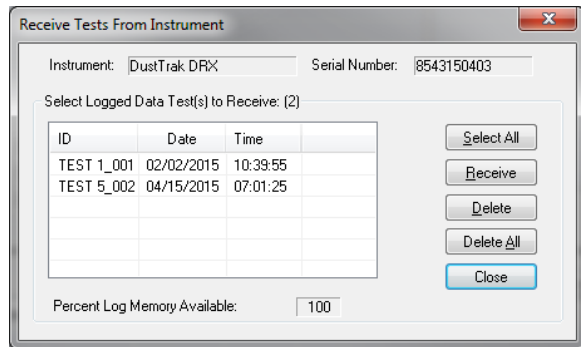
Downloading Data

Once the data has been logged to the instrument, it can be downloaded into TrakPro™ software.

Select **File->Receive** to download data from the instrument.



This will allow for the downloading of some or all of the data stored on the instrument.



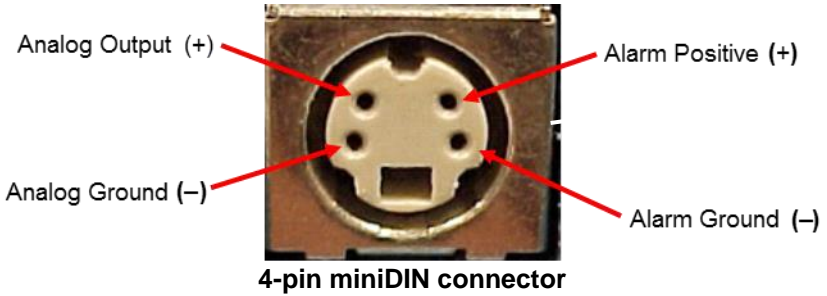
Viewing, Graphing and Exporting Data

Read the TrakPro™ software help files for information on how to view, graph and export the DustTrak™ data.

Local Analog/Alarm Output

The DustTrak™ Environmental Monitor has an Analog/Alarm Output connection on the side of the instrument.

The pin-outs for wiring are shown below.



Cable Wiring Diagram	
Brown Wire	Analog Ground
Orange Wire	Analog Out
Red Wire	Alarm (+)
White Wire	Alarm (-)
Black Wire	Shield

Figure 16: Cable Wiring Diagram

Wiring the Analog Output

System specifications:

- Output voltage: 0 to 5 VDC. With a maximum output of 15 mA.
- Output Current 4 mA to 20 mA with a maximum load impedance of 250 ohms.
- Correct polarity must be observed (see pin-outs above).

Wiring the Alarm

System specifications:

- Maximum voltage: 15 VDC (**DO NOT USE AC POWER**)
- Maximum current: 1 Amp
- Correct polarity must be observed (see pin-outs above)
- The alarm switch, located inside the DustTrak™ monitor must be located on the ground side of the alarm system.



WARNING

- The Alarm Output function **SHOULD NOT** be used to detect hazardous conditions or to provide an alarm for protecting human life, health, or safety.
- When connected to the analog out and alarm out connector, you **MUST** use safety certified equipment and/or power sources.

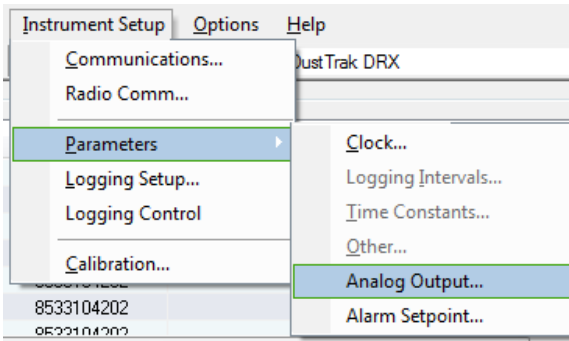


CAUTION

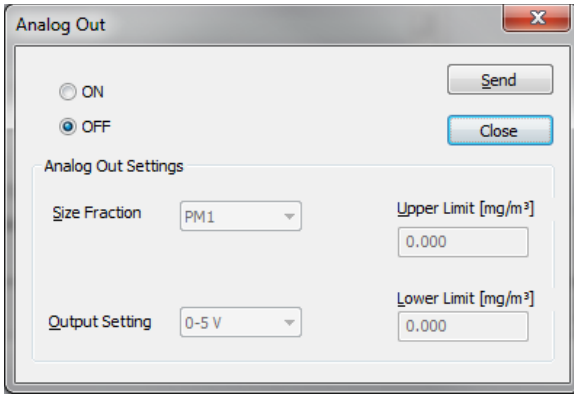
The alarm switch **MUST NOT** be wired to AC power! Failure to install the user alarm properly could damage the DustTrak™ instrument and/or void the instrument warranty! Please read and follow all instructions before wiring or operating the user alarm.

Using TrakPro™ Software to Program the Analog Output

Use TrakPro™ software to configure the Analog output. Select **Instrument Setup -> Parameters -> Analog Output...** to get to the Analog output dialog.



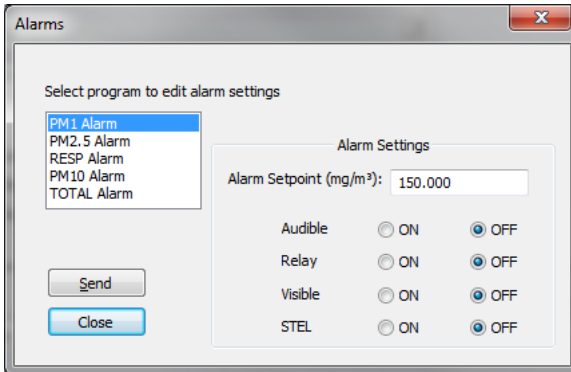
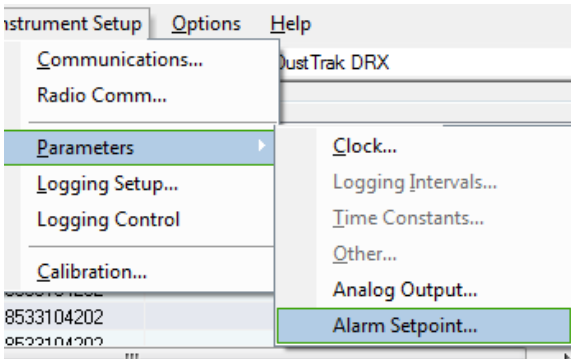
This dialog will allow for the turning on/off and configuring of the analog output.



Analog out [On, Off]	Turns analog out port on.
Size Fraction	Selects the size channel that will drive the analog out. DRX Models 8543 or 8543-M only.
Output Setting [V, mA]	Select 0–5 V or 4–20 mA.
Lower Limit [mg/m³]	Mass concentration reading of the selected channel that will correspond to 0 V or 4 mA.
Upper Limit [mg/m³]	Mass concentration reading of the selected channel that will correspond to 5 V or 20 mA.

Using TrakPro™ Software to Program Alarm Setpoints

Use TrakPro™ software to setup the Alarm Setpoints. Select **Instrument Setup -> Parameters -> Alarm Setpoint...** to get to the alarm settings dialog.



NOTE

The Alarm is dependent on the logging interval. For the DustTrak™ Environmental Monitor to alarm as soon as the Alarm Setpoint is exceeded, the logging interval must be set as low as possible (i.e., 1 second or 2 seconds). If a long test duration does not permit setting such a short logging interval, use the STEL alarm instead. The STEL is always based on 1 second concentrations and is independent of the logging interval. For more details on the STEL alarm, see section below on [STEL](#).

In Survey mode, the alarm is dependent on the time constant.

Alarms can be set of each mass channel for the DRX Models 8543 / 8543-M (PM₁, PM₂, Resp, PM₁₀ and Total). Alarms can only be set for the Total channel for the standard DustTrak™ Models 8540 / 8540-M/8542-M.

<p>Alarm Setpoint [mg/m³]</p>	<p>The alarm setpoint is the mass concentration level upon which the alarm is triggered.</p> <p>Alarm will trigger if the mass concentration, taken at the logging interval, rises above the setpoint.</p>
<p>Relay [On, Off]</p>	<p>When the relay alarm is turned on, unit will close its local relay switch when Alarm level is surpassed.</p> <p>Relay alarm can only be linked to one mass channel at a time for the DRX models 8543 / 8543-M.</p>
<p>STEL [On, Off]</p>	<p>When the STEL alarm is turned on, STEL data will be collected when Alarm level is surpassed.</p> <p>STEL alarm can only be linked to one mass channel at a time for the DRX models 8543 / 8543-M.</p> <p>See following STEL Note.</p>
<p>Audible [On, Off]</p>	<p>When the audible alarm is turned on, the instrument will activate internal beeper when the alarm level is surpassed.</p> <p>Audible alarm can only be linked to one mass channel at a time for the DRX models 8543 / 8543-M.</p>
<p>Visible [On, Off]</p>	<p>Not used for the 8540 / 8540-M / 8542-M / 8543 / 8543-M models.</p>

STEL Alarm

STEL stands for **Short Term Exposure Limit**. When a STEL alarm is selected, the instrument will inspect the data on a second by second basis, independent from the selected logging interval. If the mass exceeds the STEL limit, a STEL event triggers and the following actions will be taken.

Data	Data will be taken of the STEL alarm channel at a 1 minute logging interval for 15 minutes . This data will be stored in a separate file named STEL_XXX, where XXX will be matched to the logged data file. The instrument will also continue to log the mass concentration data at the logging interval selected.
STEL Alarm repeat	If the instrument remains over the STEL limit after the 15 minute interval, or if the instrument exceeds the STEL limit later during the sample period, additional STEL files will be generated.

STEL Data can be downloaded in TrakPro™ software similar to the standard data.

Chapter 5

Maintenance

The DustTrak™ Environmental Monitor can be maintained in the field using the instructions below.

TSI® recommends the DustTrak™ Environmental Monitor be returned to the factory for annual calibration. For a reasonable fee, TSI® will quickly clean and calibrate the unit and return it to you in “as new” working condition, along with a Certificate of Calibration. This “annual checkup” helps ensure that the instrument is always in good operating condition.



WARNING

The only user-serviceable parts inside the DustTrak™ Environmental Monitor are the gravimetric filter, pump, and sheath flow filter accessible behind the removable service panel.

The instrument case should only be opened by TSI® or a TSI® approved service technician.

NOTE

To maintain the MCERTS certification, it is required that the MCERTS model photometers (8540-M, 8542-M, 8543-M) be recalibrated on a yearly cycle.

Maintenance Schedule

The DustTrak™ Environmental Monitor requires maintenance on a regular basis. Table 1 lists the factory recommended maintenance schedule.

Some maintenance items are required each time the DustTrak™ monitor is used or on an annual basis. Other items are scheduled according to how much aerosol is drawn through the instrument. For example, TSI® recommends cleaning the inlet sample tube after 350 hours of sampling a 1 mg/m³ concentration of aerosol. This recommendation should be pro-rated according to how the instrument is used. 350 hours at 1 mg/m³ is the same amount of aerosol as 700 hours at 0.5 mg/m³ or 175 hours at 2 mg/m³, etc.

Table 1. Recommended Maintenance Schedule

Item	Frequency
Clean the inlet nozzle*	350 hr. at 1 mg/m ³ *
Replace internal HEPA filter	Every 6 months
Return to factory for cleaning and calibration	Annually
Remove and clean the 37-mm blank cassette (see Replacing Internal 37-mm Sampling Cassette section for further details)	Monthly

*Pro-rated, see discussion above.

The DustTrak™ Environmental Monitor keeps track of the accumulated amount of aerosol drawn through it since its last cleaning.

Cleaning the Inlet

The inlet should be cleaned based on the schedule in Table 1.

1. Turn the DustTrak™ monitor off.
2. Remove the 4 screws and the inlet mounting ring.
3. Unscrew the black inlet nozzle from the instrument (Figure 17).



Figure 17: Unscrew Inlet Nozzle

4. Use a cotton swab to clean the outside of the inlet nozzle body. You may dampen the swabs with water or a light solvent (e.g., isopropanol). Clean the inner diameter of the nozzle by using a small brush, along with a light solvent. Dry the nozzle by blowing it out with compressed air, or let it air-dry thoroughly.

NOTE

Be *careful* not to blow particles into the DustTrak™ monitor inlet port.



Figure 18: DO NOT Blow into Instrument

5. Screw (hand-tighten) inlet nozzle back into instrument.

Cleaning and Oiling Impactors

Follow the recommended Impactor cleaning interval for size selective Impactors as shown below. These impactors are used with models 8540, 8540-M, and 8542-M DustTrak™ Environmental instruments.

Recommended impactor maintenance interval is every two months except where the “average dust concentration” level indicated in the table shows the impactor should be cleaned more frequently:

Average dust concentration (mg/m ³)	Impactor maintenance interval
0.015	97 days
0.025	60 days
0.035	42 days
0.050	30 days
0.100	16 days
0.150	10 days
0.250	6 days
0.400	4 days

1. Unscrew Impactor. Check O-ring on the impactor base.
2. Clean outside and inside of Impactor and the impactor plate using a clean brush and a light solvent. Dry impactor parts by blowing it out with compressed air, or let it air-dry thoroughly.
3. Apply two drops of oil (included) to the impactor plate. **DO NOT** over-fill impaction plate.

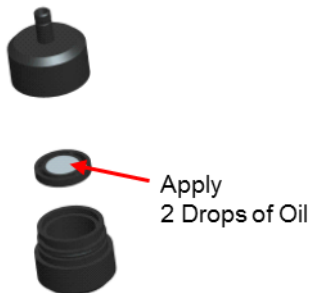


Figure 19: Apply Two Drops of Oil to Impactor Plate

4. Screw (hand-tighten) impactor back together.

Replacing the Internal Sheath Air (HEPA) Filter

TSI® recommends replacing the internal sheath air filter after every six months of use.

1. Turn the instrument off.
2. Open Instrument Service Panel (Figure 20).
3. Disconnect and remove old sheath air filter from the instrument (Figure 21).



Figure 20: Open instrument service panel

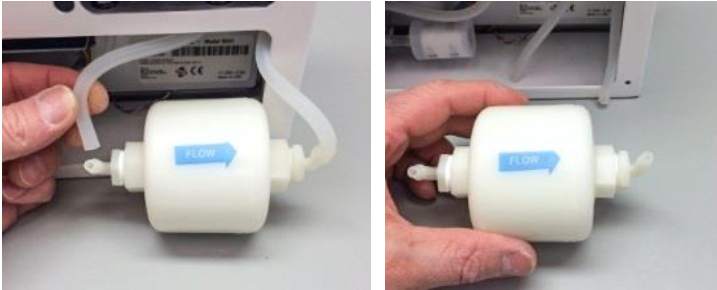


Figure 21: Disconnect and remove old sheath air filter

4. Replace with new filter (PN 854044). Ensure tubing coming from the “Y” connects to the inlet side of the filter as indicated by the Flow arrow (Figure 22).



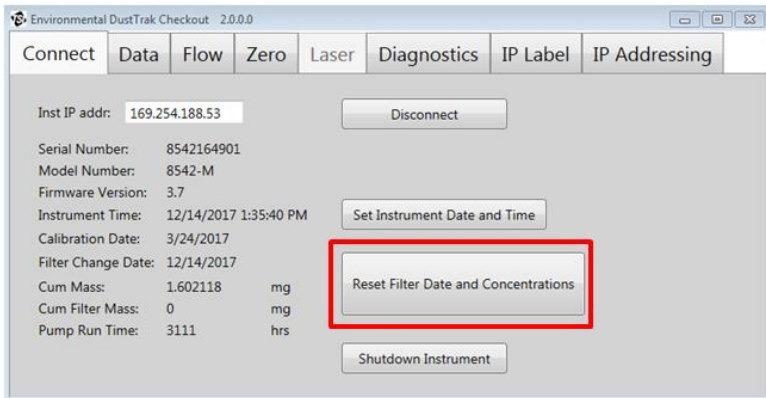
Figure 22: Replace with new filter

5. Replace cover and return to service (Figure 23).
6. **It is important to reset the instruments filter change date and cumulative filter mass concentration after replacing the Sheath air filter.** Resetting the filter concentration may clear the filter error condition shown in the Data tab of DustTrak™ Checkout Software. Reset the date and concentration by performing the following:

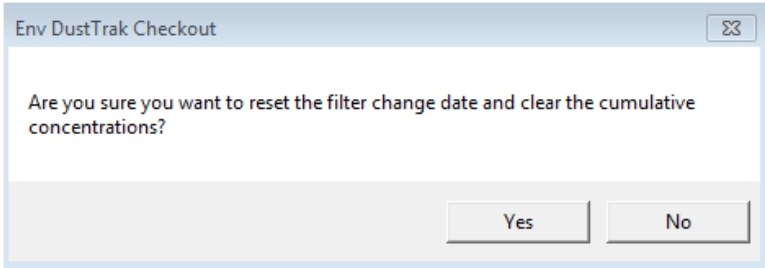


Figure 23: Replace cover

- a. Power the instrument.
- b. Open the DustTrak™ Checkout software.
- c. Connect the provided USB cable to the instrument and your personal computer.
- d. Click **Connect**.
- e. Click **Reset Filter Date and Concentrations**.



- f. A Dialog box will appear confirming that you would like to reset the change date and the cumulative filter concentration. Click **Yes** to reset the cumulative filter concentration to zero. The Checkout Software will now show zero for the **Cum Filter Mass** and the current date for the **Filter Change Date**.



- g. The Checkout software will now show, **zero for the Cum Filter Mass Concentration** and the current date for the Filter Change Date.

Replacing Pump

If the pump stops working it can be removed and replaced in the field. See Quick Start Guide included with Replacement Pump (854043) for additional details (Figure 24).

First remove Photometer from the Environmental Enclosure following the applicable steps:

1. Disconnect all cabling from photometer.
2. Remove inlet column. If inlet column includes a heated inlet, remove ferrite from the heated inlet cable and carefully pull the heated inlet cable through the key hole on the mounting ring when removing the inlet column (Figure 25a).
3. Loosen retainer ring on top of enclosure while holding photometer (Figure 25b).



Figure 24: Replacement pump (854043)

4. Pull photometer down and out of enclosure.



**Figure 25: (a) Heated inlet cable;
(b) remove retainer ring and lower photometer**

5. Have a replacement pump (P/N 854043) available.
6. Open instrument service panel (Figure 26).



Figure 26: Open instrument service panel

7. Remove the four Phillips head screws from the left-side panel (Figure 27).

NOTE

Remove only the raised-head screws. **DO NOT** remove any screws with heads flush to the surface.



Figure 27: Remove screws from left side panel

8. Pull the pump from the enclosure and detach tubing, muffler, and cable.

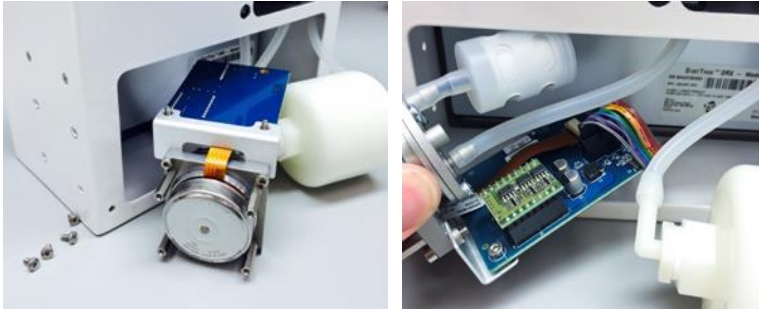


Figure 28: Pull pump from enclosure and detach tubing, muffler, and cable

9. Attach the muffler to P, tubing to V, and cable to the new pump (Figure 29).



Figure 29: Attach muffler

10. Orientate pump inside instrument with muffler (port P) located in the lower position (Figure 30).



Figure 30: Pump orientation

11. Secure the new pump inside the instrument case with the four Phillips head screws (Figure 31).
12. Replace photometer service panel and reinstall photometer inside Environmental Enclosure following the steps above in reverse order.



Figure 31: Secure new pump

Replacing Internal 37-mm Sampling Cassette

The internal 37-mm sampling cassette can be used to conduct sampling for gravimetric or analytical analysis. The instrument comes with a blank cassette containing a mesh sieve to keep large particulate out of the instrument pump. Save this cassette and the filter. The DustTrak™ Environmental Monitor is designed to have this cassette in place. The flow path will be compromised without this cassette.

On occasion, this cassette should be removed and the mesh screen cleaned by blowing with compressed air or rinsing under running water and allowing the filter to dry before replacing the cassette. The maintenance interval will vary depending on the aerosol concentration being sampled. TSI® recommends initially checking this screen **monthly** until the accumulation rate is understood. The screen should be changed out before it is completely coated with aerosol buildup.

TSI® does not provide the filter media for gravimetric or analytical sampling. When requesting cassette with filter media for gravimetric sampling, ask for a 37-mm, 2-piece, static conductive plastic cassette to ensure proper fit inside the DustTrak™ monitor.

1. To remove cassette, open instrument service panel to access the sampling cassette. Internal sampling cassette is located in the upper right opening.

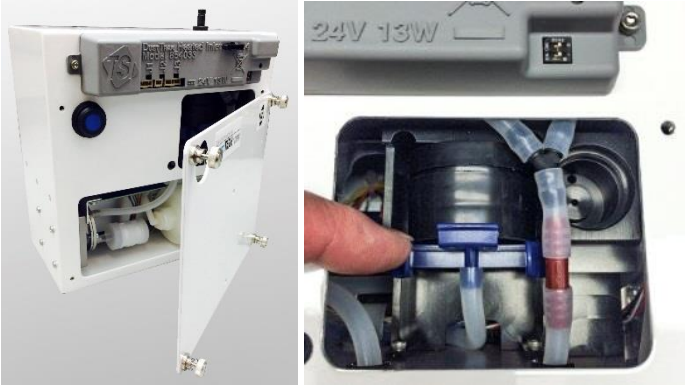


Figure 32: Remove sampling cassette

2. Pinch the blue clip to release the bottom cassette holder and remove cassette from the holder.



Figure 33: Release and remove cassette holder

3. Inspect top inlet fitting and blue cassette holder for broken pieces or missing seals (Figure 34).
4. Install a blank cassette for DustTrak™ monitor operation or a pre-weighed, 37-mm, 2-piece, conductive cassette with the appropriate filter media for the analysis to be performed.
5. Make sure the Cassette snaps securely into the inlet port on the top of the cassette holder and the bottom clip snaps securely into place. If the connection is loose, air will leak resulting in inaccurate sampling results (Figure 35).

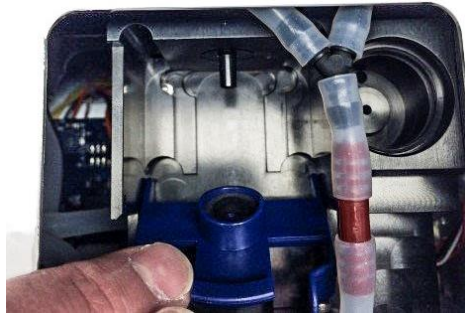


Figure 34: Inspect top inlet fitting and blue cassette holder



Figure 35: Snap cassette securely into inlet port

Return Shipping to TSI® Incorporated

Visit our website at [tsi.com/service](https://www.tsi.com/service) to initiate a Service Request form:

- Disconnect and remove all accessories. Only the photometer can be serviced.
- The model number can be found on the label on the back of the instrument. The model number will be needed for the Service Request form.
 - For 8540-M use 8540
 - For 8543-M use 8543
- Package the instrument in the original shipping container.

NOTE

If original shipping container is not available, pack instrument securely in a durable shipping carton to prevent damage during shipment. Consult with courier for packing guidance.

- Include printed copy of Service Request form inside container with instrument.
- Ship to TSI® via trackable shipping method.



Chapter 6

Troubleshooting

The table below lists the symptoms, possible causes, and recommended solutions for common problems encountered with the DustTrak™ monitor.

Symptom	Possible Cause	Corrective Action
Erratic reading.	Leak	Check connections for leaks
	Dirty inlet port and/or sample tube	Clean inlet port. Clean or replace tubing
	Internal filter(s) not installed properly (leaking)	Inspect internal filter wells to make certain the filters and O-rings are seated properly. Replace internal filters if necessary
DustTrak reading negative concentrations	Zero Drift	Increase autozero frequency
Analog output does not work	Cable/connector not correctly installed	Make sure cable connector is fully seated
	Output wired with reverse polarity	Make sure analog out (+) and analog ground (-) are wired correctly to data-logger
Alarm output does not work	Alarm function not turned on	Turn the alarm function on in TrakPro™ software
Alarm does not turn on correctly	Alarm setting incorrect	Check the alarm settings in TrakPro™ software
	Alarm output wired with reverse polarity	Alarm wires are polarized. Voltage input must be wired to alarm input (+)

Symptom	Possible Cause	Corrective Action
Instrument does not store new data	Memory is full	Delete or transfer historic data
	Instrument is in Survey mode	The instrument does not store data in survey mode. Can to manual or program log mode
Flow Error is indicated in Data set or on Environet	Flow obstruction	Remove obstruction if still present. Press any key to bypass
	Internal pump failing, indicated by inability to adjust flow rate to full range	Replace pump per instructions in maintenance section
	37-mm cassette clogged or has mass loading	Replace the filter cassette. See the maintenance section of the manual
Laser Error indicated in data set of on Environet	Laser background is too high	Remove and clean inlet nozzle. Pay close attention to the tip of the nozzle that is inserted into the instrument to ensure it is clear of any contamination
	Laser is failing	Factory service may be required
Filter Error indicated in data set or on Environet	Internal sheath air (HEPA) filter needs to be replaced	Replaced the filter per instructions in the maintenance section of this manual. Make sure to reset the filter mass and date once the filters have been changed
NOTE		
This is only a warning. The unit will continue to operate normally until the increase in pressure drop across the filter is so high that the pump can no longer maintain the set flow rate.		

Appendix A

Specifications

Specifications are subject to change without notice.

8540/8540-M/8542-M/8543/8543-M DustTrak™ Environmental Monitors are designed to operate inside a weather-proof enclosure, like TSI® Model 854038 Environmental Enclosure, sold separately.

Sensor Type	90° light scattering
Range	0.001 to 400 mg/m ³ (models 8540, 8540-M, & 8542-M) 0.001 to 150 mg/m ³ (models 8543 & 8543-M)
Resolution	±0.1% of reading or 0.001 mg/m ³ , whichever is greater
Zero Stability	±0.002 mg/m ³ 24 hours at 10 sec time constant
Particle Size Range	Approximately 0.1 to 10 µm (8540, 8540-M, 8542-M) / 0.1 to 15 µm (8543, 8543-M)
Flow Rate	3.0 L/min set at factory
Flow Accuracy	±5% factory setpoint Internal flow controlled
Temperature Coefficient	+0.001 mg/m ³ per °C
Operational Temp ..	0° to 50°C
Storage Temp	-20° to 60°C
Operational Humidity	0–95% RH, non-condensing
Time Constant	Adjustable 1 to 60 seconds
Data Logging	45 days at 1 minute samples
Log Interval	1 second to 1 hour

Physical Size (HWD)	8.25 x 8.25 x 4.25 in. (20.96 x 20.96 x 10.80 cm)
Weight	5.25 lbs (2.38 kg)
Communications ...	Cellular, Wi-Fi®, GPS/GPRS, USB (Host and Device) and Ethernet.
Power	12/24 Volts DC 50 Watts
Analog Out	8540/8540-M/8542-M/8543/8543-M: User selectable output 0 to 5 V or 4 to 20 mA User selectable scaling
Alarm Out	8540/8540-M/8542-M/8543/8543-M: Relay or sound buzzer Relay No latching MOSFET User selectable setpoint 5% deadband Connector 4-pin, Mini-DIN connectors
Internal Sampling Cassette	Removable 37-mm, 2-piece, static conductive cassette. <i>Contact AIHA Accredited Analytical Lab for guidance on selecting the proper filter media for your desired analytical testing.</i>

®Wi-Fi is a registered trademark of Wi-Fi Alliance.

Appendix B

Instrument Command Set

See the DustTrak™ Communication Manual for instrument command instructions for communicating with wireless modems and other dataloggers. Contact TSI® for a copy of the communication manual (P/N 6002481).

Connecting to the Instrument

USB and Ethernet instrument connections use the NDIS communication method, port 3602.

NIDS Communication Method

This method communicates with the instruments via USB and Ethernet connections. This method uses windows sockets.



Appendix C

DRX Advanced Calibration

The advanced calibration method is employed to yield high size segregated mass concentration accuracy for PM_{1.0}, PM_{2.5}, Respirable, and PM₁₀ size fractions. It involves two gravimetric measurements to obtain PCF and SCF. The two gravimetric measurements can be done in sequence or in parallel, depending on the gravimetric sampling device availability.

Option 1: Serial Gravimetric Calibration

When you have only one set of gravimetric sampling devices, the DustTrak™ DRX advanced calibration can be performed in two serial steps. The experimental setup is in Figure 36a. The calibration steps are outlined below:

Step 1: PCF Calibration

- Install a PM_{2.5} impactor at the inlet of the external gravimetric filter.
- Co-locate and run the gravimetric sample and DustTrak™ DRX monitor simultaneously to collect enough mass on the gravimetric filter.
- Calculate the PM_{2.5} mass concentration (PM_{2.5_Grav}) from the gravimetric filter based on the net mass collected on the filter, sampling time, flow rate, and total liters of air sampled.
- Read the DustTrak™ DRX monitor average PM_{2.5} mass concentration (PM_{2.5_DRX}) from the screen or through TrakPro™ Data Analysis Software.
- Calculate the new PCF

$$PCF_{New} = \frac{PM_{2.5_Grav}}{PM_{2.5_DRX}} \times PCF_{Old}$$

- Update the new PCF in user calibration settings.

Step 2: SCF Calibration

- Install a PM₁₀ impactor at the inlet of the external gravimetric filter.

- Co-locate and run the gravimetric sample and DustTrak™ DRX monitor simultaneously to collect enough mass on the gravimetric filter.
- Calculate the PM₁₀ mass concentration (PM_{10_Grav}) from the gravimetric filter based on the net mass collected on the filter, sampling time, flow rate, and total liters of air sampled.
- Read the DustTrak™ DRX monitor average PM_{2.5} (PM_{2.5_DRX}) and PM₁₀ (PM_{10_DRX}) mass concentration from the screen or through TrakPro™ Data Analysis Software.
- Calculate the new SCF

$$SCF_{New} = \left(\frac{PM_{10_Grav} - PM_{2.5_DRX}}{PM_{10_DRX} - PM_{2.5_DRX}} \right)^{\frac{1}{3}} \times SCF_{Old}$$

- Update the new SCF in user calibration settings.

Option 2: Parallel Gravimetric Calibration

When you have two sets of gravimetric sampling devices, the DustTrak™ DRX monitor advanced calibration can be performed in the parallel configuration as shown in Figure 36b. The calibration steps are outlined below:

1. Install a PM_{2.5} and a PM₁₀ impactor at the inlet of the two external gravimetric filters, respectively.
2. Co-locate and run the gravimetric samples and DustTrak™ DRX monitor simultaneously to collect enough mass on the gravimetric filters.
3. Calculate the PM_{2.5} (PM_{2.5_Grav}) and PM₁₀ (PM_{10_Grav}) mass concentrations from the gravimetric filters based on the net mass collected on the filter, sampling time, flow rate, and total liters of air sampled.
4. Read the DustTrak™ DRX monitor average PM_{2.5} and PM₁₀ mass concentration (PM_{2.5_DRX} and PM_{10_DRX}) from the DRX screen or through TrakPro™ Data Analysis Software.
5. Calculate the new PCF

$$PCF_{New} = \frac{PM_{2.5_Grav}}{PM_{2.5_DRX}} \times PCF_{Old}$$

and the new SCF

$$SCF_{New} = \left(\frac{PM_{10_Grav} - PM_{2.5_Grav}}{PM_{10_DRX} - PM_{2.5_DRX}} \right)^{\frac{1}{3}} \times SCF_{Old}$$

6. Update the new SCF and PCF in the user calibration settings.

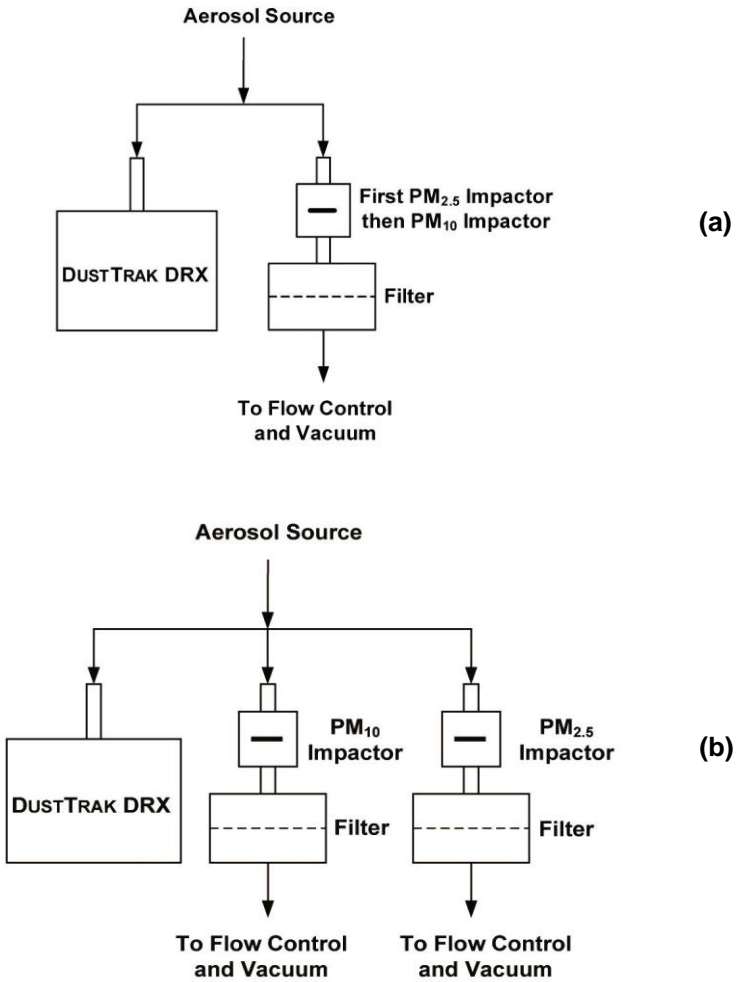


Figure 36: Experimental Setup for (a) Serial and (b) Parallel Gravimetric Calibration